

STEP 1

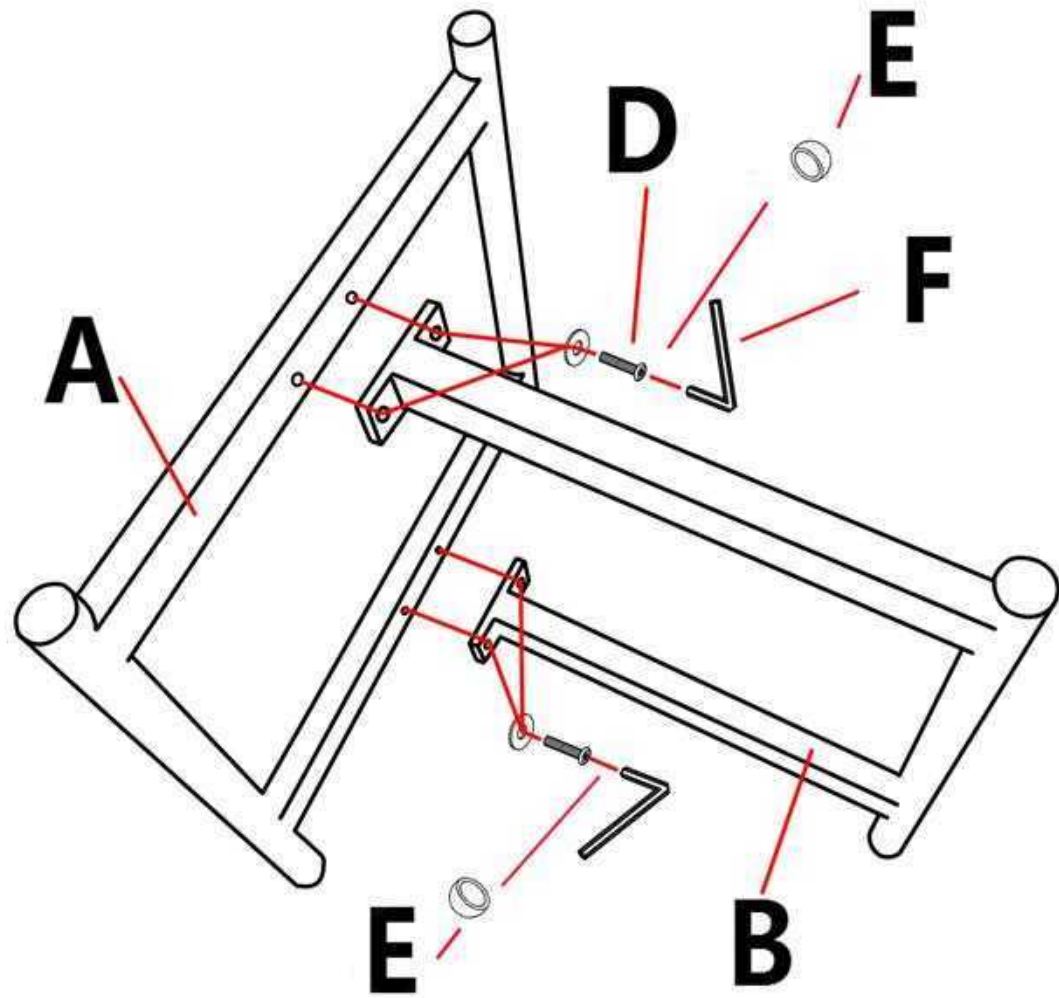

STEP 2

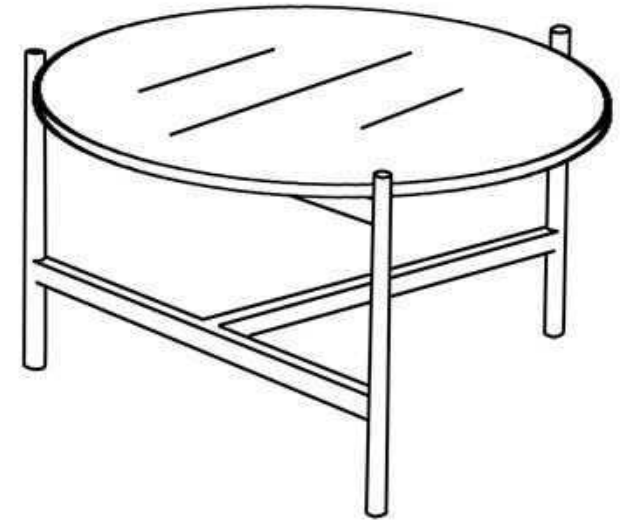
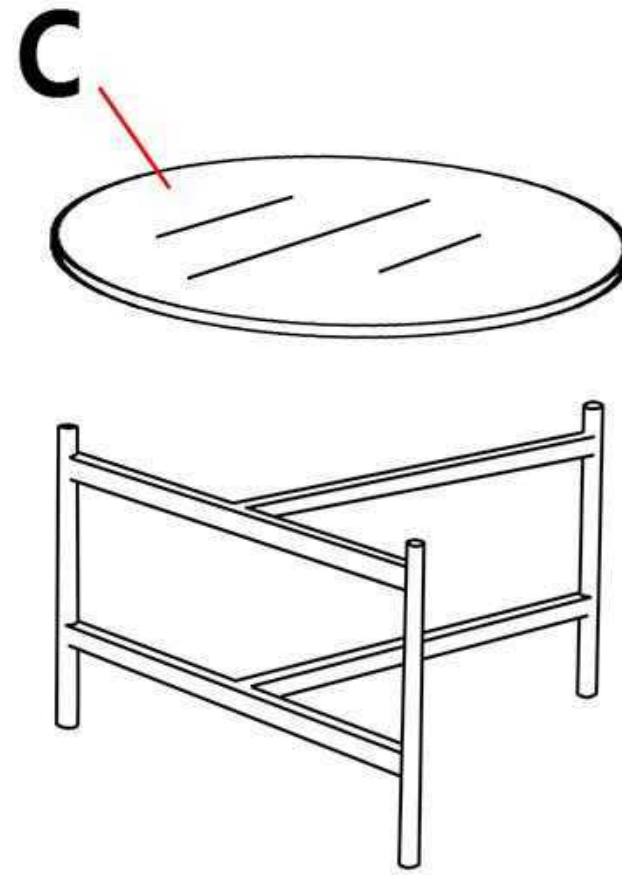

A 1 PC

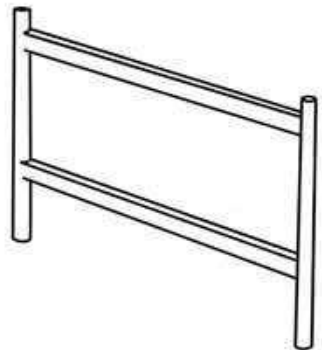

B 1 PC

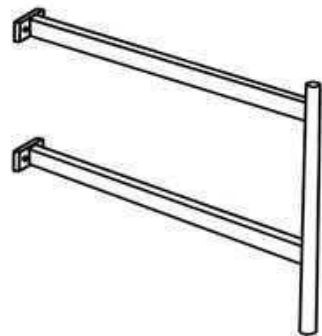

C 1 PC

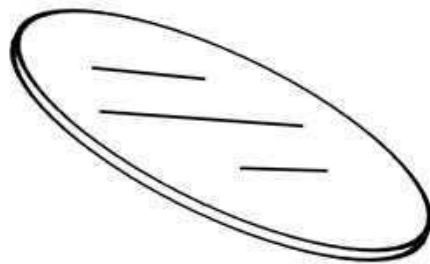

D 4 PCS



M6*16mm

E 4 PCS

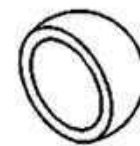

F 1 PC



STEP 1

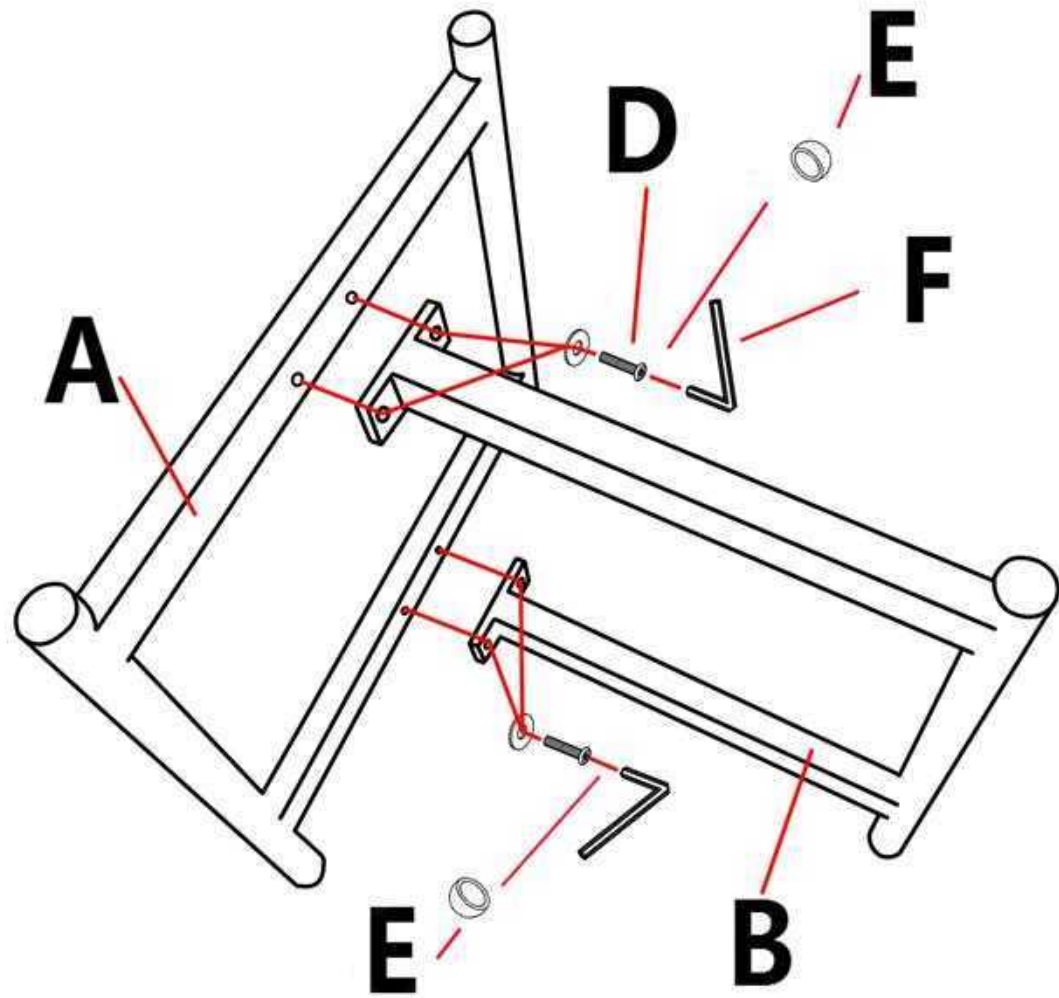

STEP 2

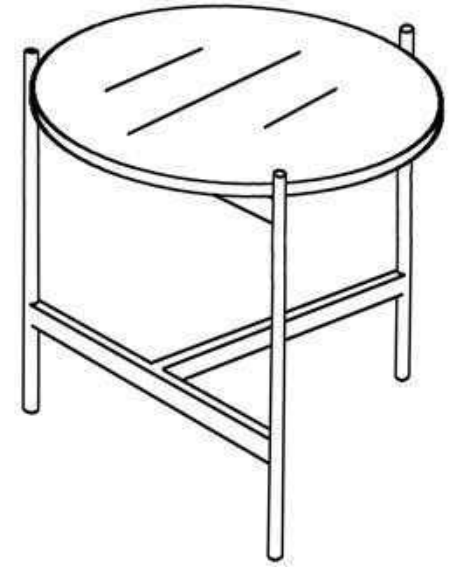
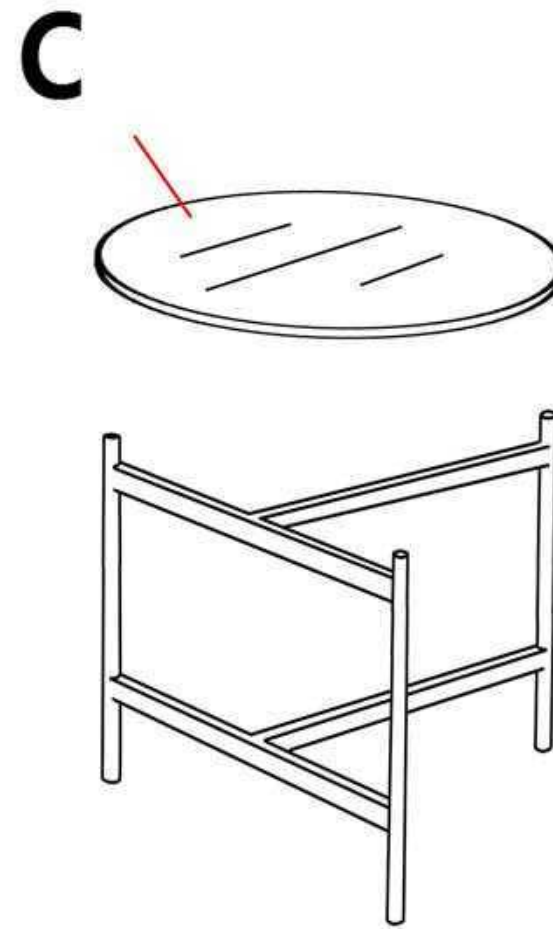

A 1 PC

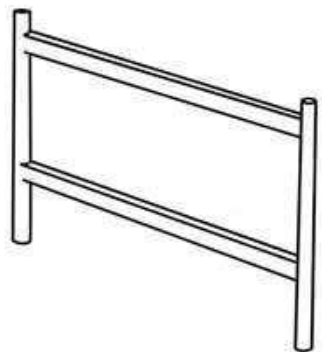

B 1 PC

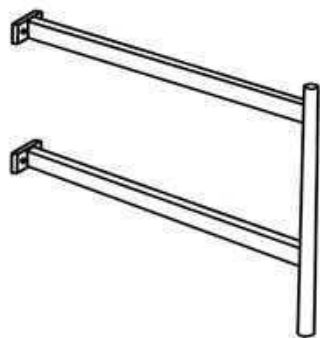

C 1 PC

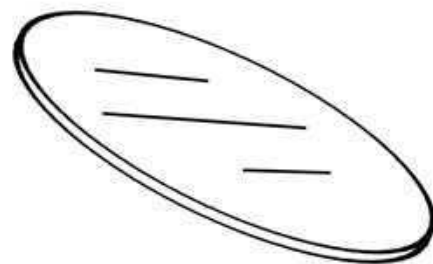

D 4 PCS



M6*16mm

E 4 PCS

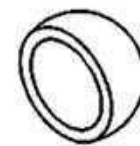

F 1 PC

